

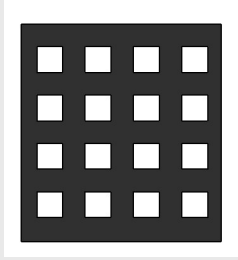

Körbe Ø 80 mm Polymer
Paniers Ø 80 mm Polymère
Baskets Ø 80 mm Polymer

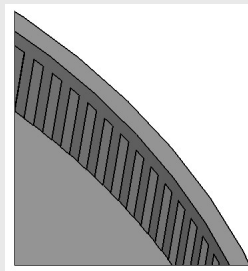

Mesh 0.64 x 0.64 mm

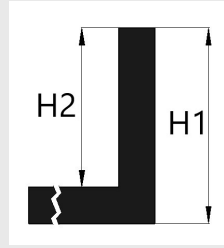

Schlitze 0.60 mm
Fentes 0.60 mm
Slots 0.60 mm

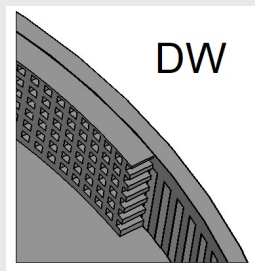

Doppelwand
Double paroi
Double outer wall

Art.No 15880

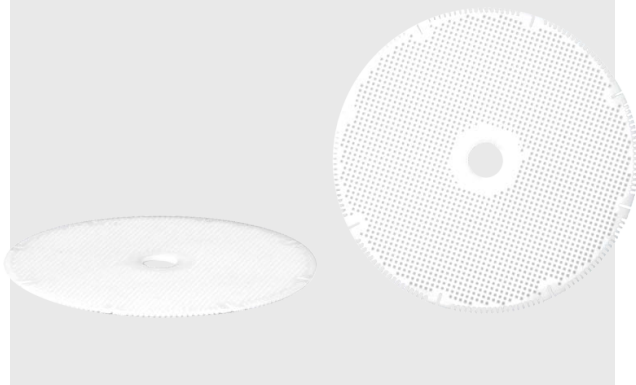

Deckel für Korb
Couvercle pour panier
Lid for basket

Art.No 15880A



Deckel für Korb, antistatisch
Couvercle pour panier, antistatique
Lid for basket, antistatic



Körbe Ø 80 mm Polymer
Paniers Ø 80 mm Polymère
Baskets Ø 80 mm Polymer

Art.No 15881
Art.No 15901 = DW



ohne Unterteilung
sans séparations
without separations

H1=8 mm / H2=6.5 mm

Art.No 15881A



Antistatisch, ohne Unterteilungen
Antistatique, sans séparations
Antistatic, without separations

H1=8 mm / H2=6.5 mm

Art.No 15882
Art.No 15893 = DW



4 Unterteilungen
4 Séparations
4 Separations

H1=8 mm / H2=6.5 mm

Art.No 15882A



Antistatisch, 4 Unterteilungen
Antistatique, 4 Séparations
Antistatic, 4 Separations

H1=8 mm / H2=6.5 mm



Körbe Ø 80 mm Polymer
Paniers Ø 80 mm Polymère
Baskets Ø 80 mm Polymer

Art.No 15883
Art.No 15892 = DW

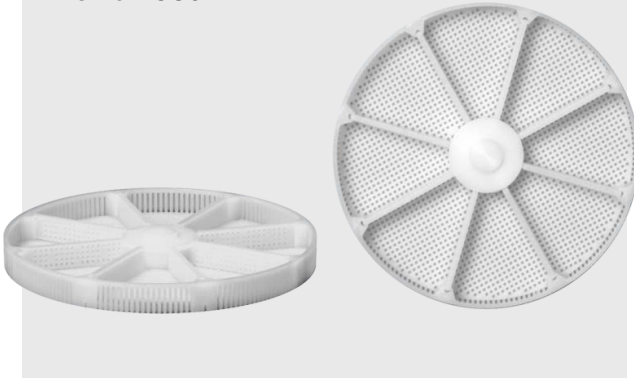

8 Unterteilungen
8 Séparations
8 Separations

H1=8 mm / H2=6.5 mm

Art. No 15883A



Antistatisch, 8 Unterteilungen
Antistatique, 8 Séparations
Antistatic, 8 Separations

H1=8 mm / H2=6.5 mm

Art.No 15884
Art.No 15898 = DW

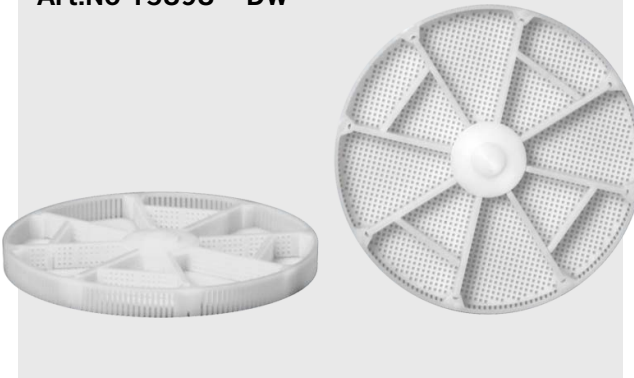

12 Unterteilungen
12 Séparations
12 Separations

H1=8 mm / H2=6.5 mm

Art.No 15884A



Antistatisch, 12 Unterteilungen
Antistatique, 12 Séparations
Antistatic, 12 Separations

H1=8 mm / H2=6.5 mm



KÖRBE UND ZUBEHÖR | PANIERS ET ACCESSOIRES | BASKETS AND ACCESSORIES

Körbe Ø 80 mm Polymer
Paniers Ø 80 mm Polymère
Baskets Ø 80 mm Polymer



16 Unterteilungen
16 Séparations
16 Separations

H1=8 mm / H2=6.5 mm



Antistatisch, 16 Unterteilungen
Antistatique, 16 Séparations
Antistatic, 16 Separations

H1=8 mm / H2=6.5 mm



Antistatisch, 72 Unterteilungen
Antistatique, 72 Séparations
Antistatic, 72 Separations

H1=8 mm / H2=6.5 mm



Kapsel für Kleinteile, antistatisch, 4 Unterteilungen
Capsule petits pièces, antistatique, 4 séparations
Capsule for small parts, antistatic, 4 separations

H1=6 mm / H2=4.6 mm



**Körbe Ø 80 mm Polymer
Paniers Ø 80 mm Polymère
Baskets Ø 80 mm Polymer**



4 Unterteilungen, für Platinen Ø 38 mm
4 Séparations, pour platines Ø 38 mm
4 Separations, for mainplates Ø 38 mm

H1=8 mm / H2=6.5 mm



4 Unterteilungen, für Platinen Ø 34 mm
4 Séparations, pour platines Ø 34 mm
4 Separations, for mainplates Ø 34 mm

H1=8 mm / H2=6.5 mm



9 Unterteilungen, für Platinen Ø 39 mm
9 Séparations, pour platines Ø 39 mm
9 Separations, for mainplates Ø 39 mm

H1=8 mm / H2=6.5 mm



4 Unterteilungen, für Platinen Ø 25 mm
4 Séparations, pour platines Ø 25mm
4 Separations, for mainplates Ø 25 mm

H1=8 mm / H2=6.5 mm



Körbe Ø 80 mm Polymer
Paniers Ø 80 mm Polymère
Baskets Ø 80 mm Polymer

Art.No 15897
Art.No 15896
Art.No 15998



ohne Unterteilung
sans séparations
without separations

H1=16 mm / H2=14.50 mm
H1=24 mm / H2=22.50 mm
H1=40 mm / H2=38.50 mm

Art.No 15902



4 Unterteilung
4 Séparations
4 Separations

H1=16 mm / H2=14.50 mm

Art.No 15899



8 Unterteilung
8 Séparations
8 Separations

H1=16 mm / H2=14.50 mm

Art.No 15905



4 Unterteilungen
4 Séparations
4 Separations

H1=24 mm / H2=22.50 mm



KÖRBE UND ZUBEHÖR | PANIERS ET ACCESSOIRES | BASKETS AND ACCESSORIES

Körbe Ø 80 mm Polymer
Paniers Ø 80 mm Polymère
Baskets Ø 80 mm Polymer

Art.No 15908



8 Unterteilungen
8 Séparations
8 Separations

H1=32 mm / H2=30.50 mm

Art. No 15910

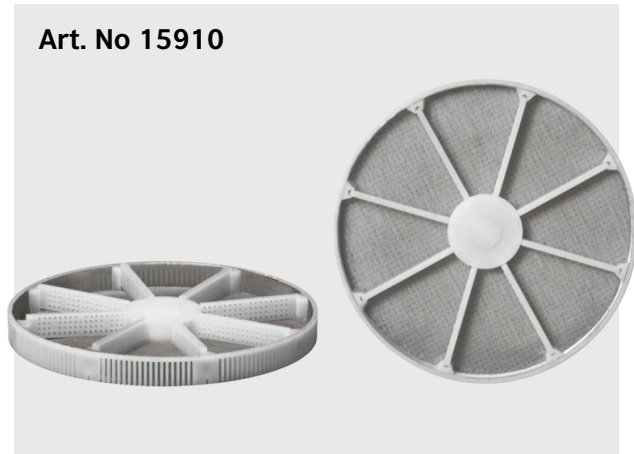

Inox-Netz; Maschenweite 0.15 x 0.15 mm
Filet-Inox, maillage 0.15 x 0.15 mm
Inox-mesh, mesh size 0.15 x 0.15 mm

H1=8.0 mm / H2=6.0

Art.No 15885



6 Unterteilungen, 2 x 17131
6 Séparations, 2 x 17131
6 Separations, 2 x 17131

H1=8.0 mm / H2=6.5 mm / H3=12.5 mm

Illustration

